

The following features are available in this PDF document.



Quick Keyword Search

Enter the keyword in the search box and hit the search button



Quick Jump between Chapters

Click the title of a specific chapter on the Contents to jump to it

*Reading software such as Adobe Reader is needed to support the functions above.



CRANE 4

User Guide

Contents

| | |
|----------------------------------------------------------------------------------------------------------------------------------------|----|
| □ Product List | |
| Product List | 1 |
| □ Get to Know CRANE 4 | |
| Get to Know CRANE 4 | 4 |
| □ Battery and Charging | |
| □ Mounting and Balancing | |
| Mounting the Tripod | 7 |
| Mounting the Camera | 7 |
| Installing a Fill Light Reflector | 12 |
| Installing TransMount Wrist Rest 2S and TransMount Extendable Sling Grip 2S (hereinafter referred to as “Sling Grip” and “Wrist Rest”) | 13 |
| Balancing | 15 |
| □ How to Use CRANE 4 | |
| Button Description | 17 |
| Touchscreen Introduction | 19 |
| Touchscreen Menu | 20 |
| Motor Torque Adjustment | 21 |
| Bluetooth Shutter Control | 23 |
| Gimbal Modes Description | 24 |
| Manual Reposition | 28 |
| Use with TransMount Video Transmission Transmitter (AI) (hereinafter referred to as “transmitter AI”) | 29 |
| Downloading the App | 33 |
| How to Connect | 33 |

| | |
|---------------------------------------------------------|----|
| ZY Play Feature Description | 34 |
| <input type="checkbox"/> Firmware Upgrade & Calibration | |
| Circumstances When Calibration Is Needed | 35 |
| Six-side Calibration | 35 |
| Motor Fine-tuning | 37 |
| Firmware Upgrade | 37 |
| <input type="checkbox"/> Product Specifications | |
| <input type="checkbox"/> Disclaimer and Warning | |
| Reading Tips | 41 |
| WARNING | 41 |
| Safe Operation Guidelines | 42 |
| <input type="checkbox"/> Warranty Card | |
| Warranty Period | 43 |
| Warranty Exclusions | 43 |
| Warranty Claim Procedure | 43 |
| <input type="checkbox"/> Contact Card | |

Product List

Before using this product, please check carefully that all the following items are included in the product package. In case that any item is found missing, please contact ZHIYUN or your local selling agent.



Gimbal x1



Lower-layer Quick Release Plate x1



Tripod x1

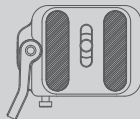

Upper-layer Quick Release Plate x1

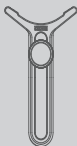
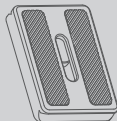
Lens Support x1
Lens Support Lock Screw x1

Camera Backing Base x1



Quick Start Guide x1

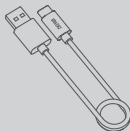

USB Type-C Cable x 1

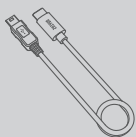

Type-C to Mini USB LN-NBUC-A01
Camera Control Cable x1

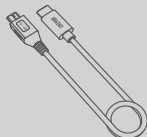

Type-C to Micro USB LN-MBUC-A02
Camera Control Cable x1

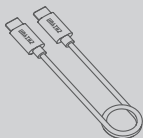

Type-C to Type-C USB LN-UCUC-A02
Camera Control Cable x1

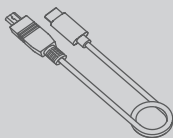

Type-C to Multi USB LN-UCUS-A03
Camera Control Cable x1



Fill Light Diffuser x1



Storage Bag x1

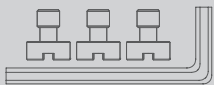

1/4" Screw x3
M4 Wrench x1*



Sling Grip x1*

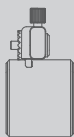

Wrist Rest x1*

Items marked “*” are included in CRANE 4 COMBO.

Get to Know CRANE 4

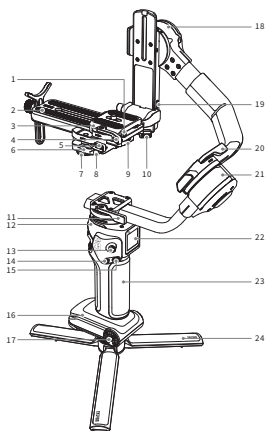

1. Upper-layer Quick Release Plate Safety Lock
2. Lower-layer Quick Release Plate
3. Upper-layer Quick Release Plate
4. Upper-layer Quick Release Plate Latch
5. Quick Release Plate Latch
6. Level Mount
7. Camera Installation Latch
8. Quick Release Plate Safety Lock
9. Quick Release Plate Leveling Base
10. Quick Release Plate Leveling Base Latch
11. Pan Axis Latch
12. Pan Axis Motor

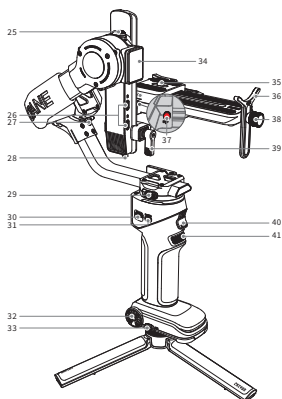

13. Joystick
14. Photo/Video Button
15. Mode Switch
16. Gimbal Base
17. Sling Grip Installation Screw Hole
18. Tilt Axis Motor
19. Camera/Image Transmission Control Port
20. Roll Axis Latch
21. Roll Axis Motor
22. Touchscreen
23. Gimbal Handle
24. Tripod
25. Tilt Axis Lock Switch
26. Focus Motor Control Port

- 27. Roll Axis Lock Switch
- 28. Level Mount Safety Lock
- 29. Pan Axis Lock Switch
- 30. Fill Light Control Wheel
- 31. Power Button
- 32. Wrist Rest Screw Hole
- 33. Firmware Upgrade/Charging Port
- 34. Fill Light
- 35. 1/4" Threaded Hole
- 36. Lens Support
- 37. Quick Release Plate Leveling Base Latch
- 38. Lens Support Lock Screw
- 39. Level Mount Lock Screw
- 40. Trigger Button
- 41. Adjustment Wheel

Battery and Charging

CRANE 4 adopts built-in battery. When using CRANE 4 for the first time, please activate the gimbal by fully charging the battery to ensure the proper function of the gimbal.

Charging method: Use provided USB Type-C cable to connect the USB charger (not included in the package) to charge CRANE 4. It is recommended to use USB chargers that meet the PD protocol. (supports 24W PD charging at most).

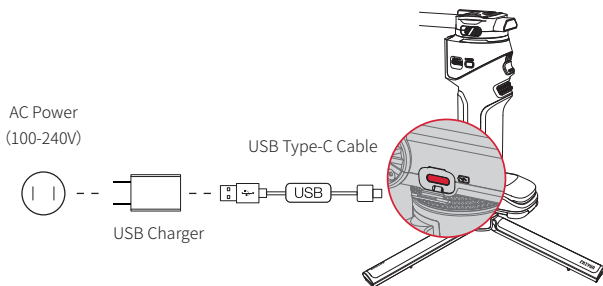

- ① USB charger is not provided.
- ② Please power off CRANE 4 to charge.

Mounting the Tripod

Mount the tripod to the bottom of the CRANE 4 handle, then unfold the tripod and place the CRANE 4 on a flat surface.

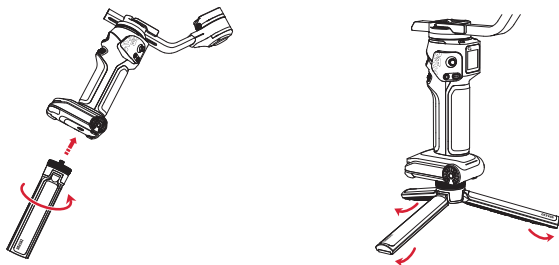

Mounting the Camera

1. Each axis of the gimbal is equipped with a lock switch. You can use these lock switches to lock the axes for convenient installation and storage. The storage state is the default state. Please toggle the lock switch to unlock the three axes, expand the gimbal as shown in the image, and lock the axes again for convenient camera installation.

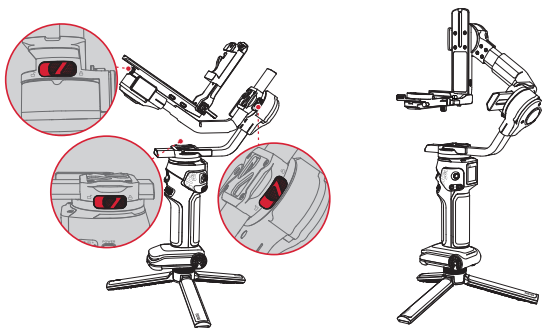

- ① Please mount the camera before powering on CRANE 4 and balance the gimbal. Do not power on CRANE 4 when there's no camera mounted on it.
- ② Before mounting the camera, make sure it is prepared ahead of time. Remove the lens cap and make sure the camera's battery and memory card are already in place.

2. Install the camera onto the upper quick-release plate and tighten the screws ①. Install the upper quick-release plate with the camera onto the lower quick-release plate ②, and lock the upper quick-release plate latch ③. Mount the lens support onto the lower quick-release plate, adjust the height of the lens support according to the lens position to ensure that the lens support can hold the camera lens securely ④, and then tighten the screws ⑤.

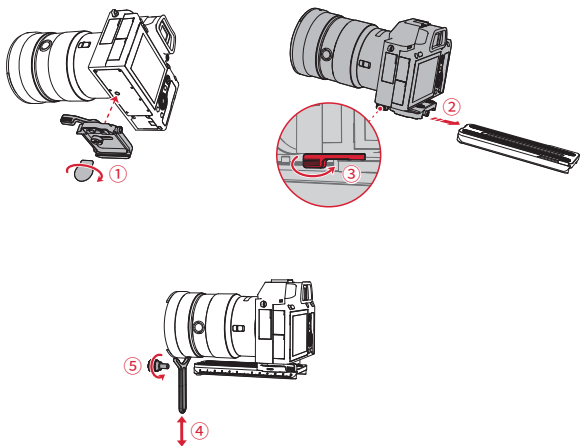

- ⚠ When the camera lens is long and heavy, it is necessary to install a camera lens support to ensure that the lens is securely mounted. You can decide whether to install a camera lens support based on your actual scenarios.

💡 If installing the camera with a dual-layer quick-release plate does not allow for balancing, you can use a camera backing base and a lower quick-release plate to install the camera. First, mount the camera onto the camera backing base and tighten the screw ①. Then, install the camera backing base and camera assembly onto the quick-release plate ② and tighten it with screws ③. Install the camera lens support onto the quick-release plate and adjust the height of the lens support according to the position of the lens so that the support can just hold the camera lens, ensuring that the lens is securely mounted ④. Finally, tighten the screw ⑤.

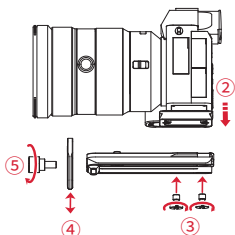
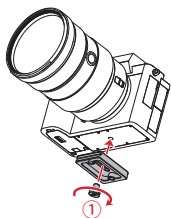

3. In the Landscape Orientation

Unlock the quick release plate latch ①, then install the dual-layer quick-release plate and camera assembly onto the quick release plate leveling base ②. Finally, tighten the latch ③.

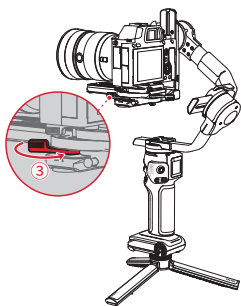
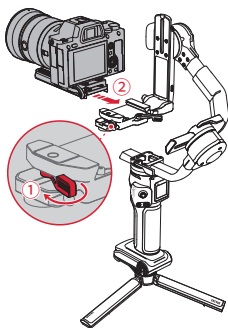

4. In the Portrait Orientation

Unlock the quick release plate leveling base latch ① . Hold the leveling base safety lock ② and push it to the left until it is detached from level mount ③ . Install the leveling base onto the tilt axis arm ④ , then lock the leveling base latch ⑤ . Install the camera and dual-layer quick-release plate assembly onto the leveling base ⑥ , and finally, lock the quick release plate latch ⑦ .

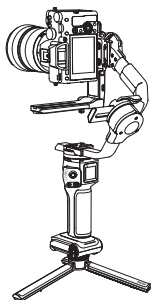
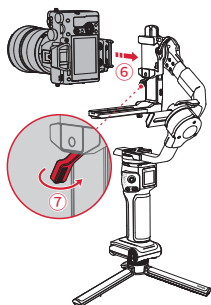
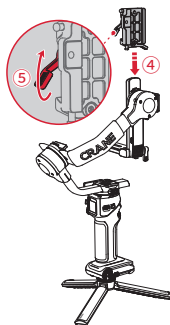
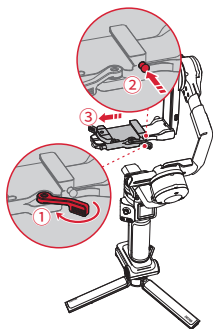

💡 To remove the camera (in landscape/portrait orientation), first unlock the upper quick-release plate latch ①, then hold down the safety lock of the upper quick-release plate ② and slide the camera and upper quick-release plate assembly out together ③.

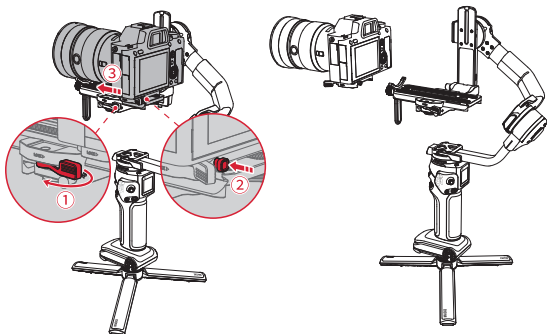

5. Connect the camera control port and camera/image transmission control port of the gimbal with a camera control cable.

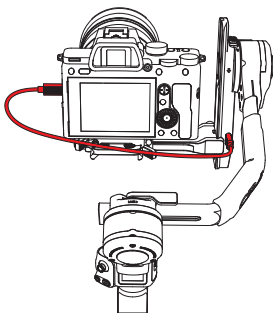

💡 There are four camera control cables: Type-C to Multi USB/Type-C to Type-C USB / Type-C to Micro USB / Type-C to Mini USB. Choose the correct cable corresponding to the USB port type of the camera. For the compatibility details, please visit the official website of ZHIYUN (www.zhiyun-tech.com) and check the CRANE 4 Camera Compatibility List.

Installing a Fill Light Diffuser

Align the opening of the fill light diffuser with the fill light of CRANE 4, then cover the diffuser over the fill light to complete installation.

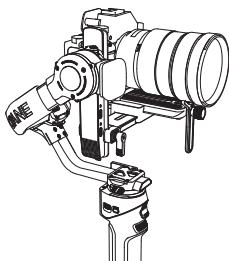
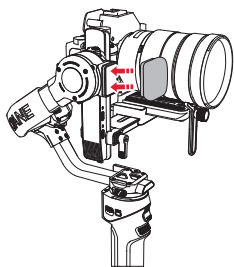

Installing TransMount Wrist Rest 2S and TransMount Extendable Sling Grip 2S (hereinafter referred to as “Sling Grip” and “Wrist Rest”)

Installing Sling Grip

Align the installation screw of the sling grip with the installation screw hole ① , adjust the sling grip to the appropriate position and tighten the screw ② . Rotate the sling grip to the far right ③ , and tighten the sling grip lock screw after adjustment is completed ④ . You can loosen the sling grip adjustment ring clockwise ⑤ to adjust the length of the sling grip. Tighten the adjustment ring when the adjustment is done ⑥ . The sling grip can also be rotated to the far left and adjusted for dual-hand use.

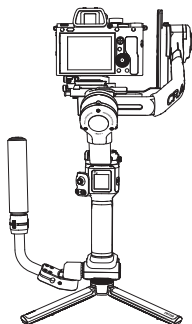
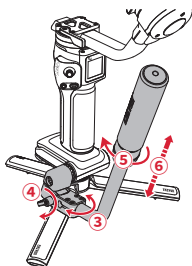
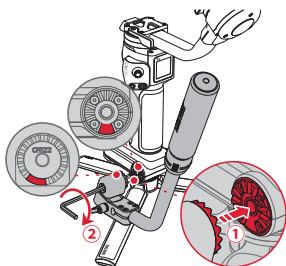

Dual-Hand Mode

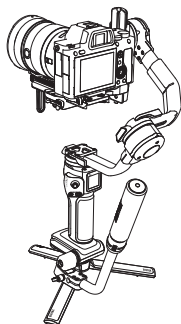

Sling Mode

Installing Wrist Rest

Align the installation screw of the wrist rest with the installation screw hole ①, adjust the wrist rest to the appropriate position and tighten the screw ②, and the installation is completed. You can turn the wrist rest adjusting screw to adjust the position ③.

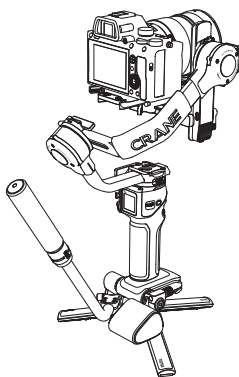
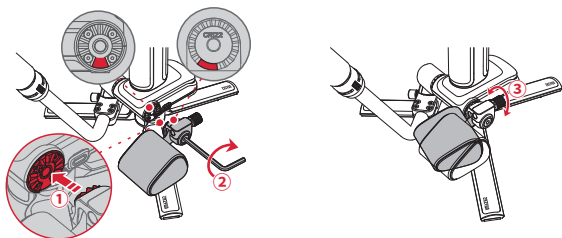

Installation completed

 The sling grip can be freely extended and contracted, and you can adjust its length according to your usage habits. For a better user experience, when using it with both hands, please do not adjust the length of the sling grip to be too long. The position of the wrist rest will affect your comfort during use, so please pay attention to adjusting its angle appropriately.

Balancing

1. Horizontal Balance of the Tilt Axis

Unlock the tilt axis lock switch ① and loosen the quick release plate latch ② . Push the camera to move forward or backward ③ until the camera can stay still and almost level with its lens facing front ④ . Complete this step by tightening up the quick release plate latch ⑤ .

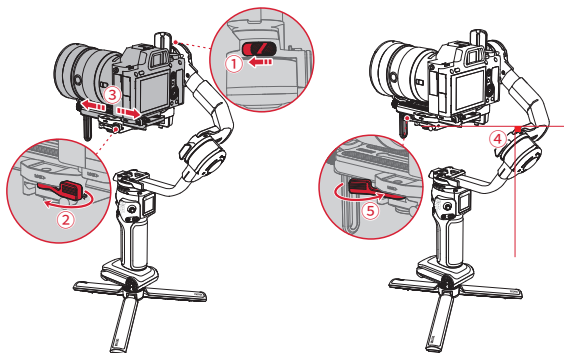

2. Vertical Balance of the Tilt Axis

Make the lens face up, loosen the level mount lock screw ① . Push the whole level mount to move forward or backward ② . Push until the camera can stay still with the lens facing up (i.e.the camera stays still and vertical to the ground) ③ . Complete this step by tightening up the screw ④ .

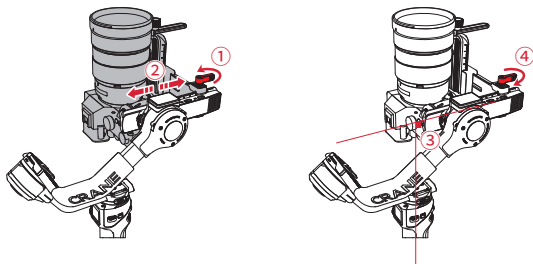

3. Roll Axis Balance

Unlock the roll axis ① and loosen the roll axis latch ② . Push the roll axis to move left or right ③ until the camera can stay still and horizontal to the ground ④ . Complete this step by tightening up the latch ⑤ .

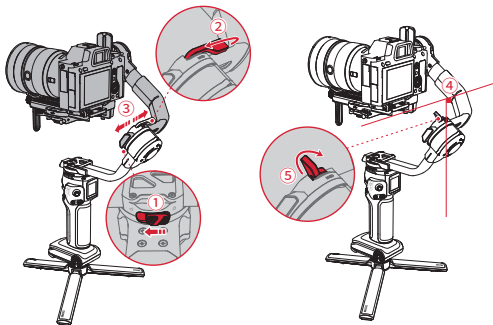

4. Pan Axis Balance

Unlock the pan axis ① , loosen the pan axis latch ② , hold and slightly tilt the handle, push the pan axis to move left or right ③ until the pan axis can stay still in any position. Complete this step by tightening up the pan axis latch ④ .

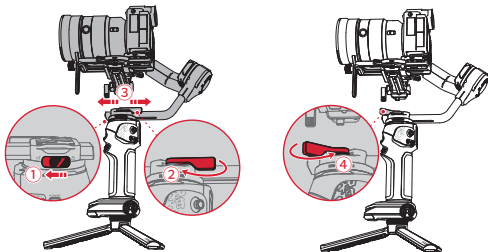

- 💡 ① The balancing steps for the portrait orientation are the same as the landscape orientation.
- ② You can also first unlock the three axes and power on the gimbal, use the "balance check" function in the main menu. The red balance indicator light indicates that the axis is not balanced, while the white balance indicator light indicates successful balancing.
- ③ After balancing CRANE 4 the motor torque needs to be adjusted for proper function. For the adjustment details, please see the methods introduced in "Motor Torque Adjustment".

Button Description

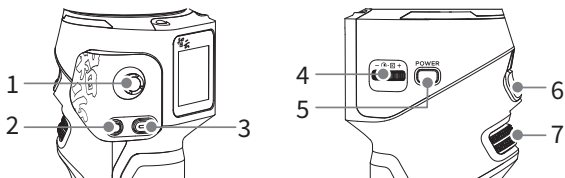

1. Joystick

Push up/down/left/right to control the gimbal to rotate.



2. Photo/Video Button

Half press: Activate auto-focus on certain cameras.

Long press: Take a photo.

Single press: Start/stop filming a video.



3. Mode Switch

Single press: Switch among PF/L/F mode.

Double press: Switch among POV/V/Portrait mode.

Long press: Sleep/wake mode for the gimbal motors.



4. Fill Light Control Wheel

Single press:

When the fill light is on, press to switch between fill light brightness/color temperature level.

Scroll: When the fill light is on, scroll to adjust the fill light brightness/color temperature level.

Long press: Turn on/off the fill light.



5. Power Button

Long press: Turn on/off the gimbal.



6. Trigger Button

Single press:

Switch to customized gimbal mode (Follow mode by default)/Return to the previous mode.

Double press: Gimbal reposition.

Triple press: Selfie mode.

Long press:

Enter Go mode. Release to return to the previous mode.

When in the portrait orientation, long press to lock the gimbal. Motors of three axes won't move with the handle. Release to unlock the gimbal and the motors of the tilt axis and roll axis will move with the handle.



7. Adjustment Wheel

Scroll: Adjust parameters customized in the screen menu (aperture, shutter, ISO, digital focus/zoom, roll axis, tilt axis, pan axis).

Touchscreen Introduction

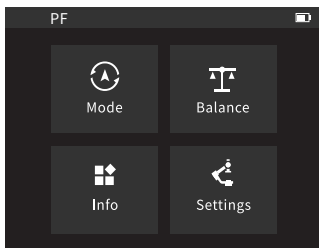

Main page (set as default)

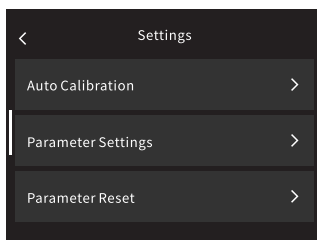

Gimbal Settings Interface

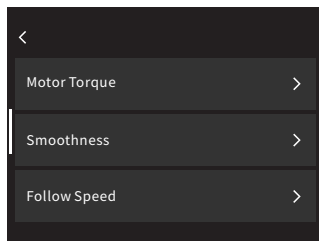

Parameter Settings Interface

💡 Swipe right at the left edge of the screen to return to the previous menu.

Touchscreen Menu



Mode:

For selecting gimbal modes. Available modes are: Pan Follow Mode (PF)/Lock Mode (L)/POV Mode (POV)/ Follow Mode (F)/Go Mode (GO)/Vortex Mode (V)/Portrait Mode



Balance:

Can check and view the balance status of three gimbal axes in real-time.



Info:

1. Language: Switch the language of the touchscreen menu (simplified Chinese/English)
2. Device Info: See the device information such as device name/device model/SN/firmware version
3. Factory Reset: Tap to factory reset the gimbal.



Settings:

1. Auto Calibration: To perform auto-calibration after the balancing is finished.
2. Parameter Settings: Sets the motor torque/smoothness/follow speed/joystick speed/deadband of the gimbal.
3. Parameter Reset: Reset the parameters to default.
4. Control Wheel: Customize the adjustment wheel. Can be customized to control aperture/shutter/ISO/zoom/focus/roll axis/tilt axis/pan axis
5. Control Wheel Setting: Sets the orientation/sensitivity of adjustment wheel parameter adjustment.
6. Follow Focus Wheel: Set the sensitivity/AB point/direction of the follow focus wheel.
7. Trigger Button: Customize the gimbal mode when pressing the trigger button once.
8. Bluetooth Shutter Control: Connect the camera Bluetooth to wirelessly control the camera.
9. Motor Fine-tuning: Fine-tune the roll axis/tilt axis angle of the gimbal.
10. Shooting: Set the shooting features in the gimbal (Panorama/Timelapse/Motionlapse/V Mode).
11. Balance Indicator Light: Sets the on/off of the balance indicator light.

Motor Torque Adjustment

After balancing CRANE 4, the motor torque needs to be adjusted for proper function. You can adjust the motor torque according to the weight of your camera and lens, so that the CRANE 4 can be used in its ideal state. Following are two methods for adjustment. It is recommended to use auto-calibration.

1. Auto calibration:

Auto calibration will adjust the motor torque according to the weight of the carried camera and lens.

Operation steps:

Select "Settings" - "Auto Calibration", tap to enter calibration. You can see the calibration progress on the screen.

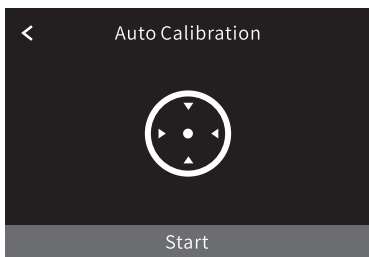

💡 When performing auto-calibration, please make sure that the gimbal is balanced, the three axes are unlocked and the gimbal is straightly put on a flat surface. Please don't touch the gimbal when calibrating.

2.Motor Torque:

Three levels (Low/Medium/High) are provided based on the mainstream lens combo weight in the market. Select the appropriate level according to the weight of the carried camera and lens.

Operation steps:

Select "Settings" - "Parameter Settings" - "Motor Torque" to enter motor torque setting interface.

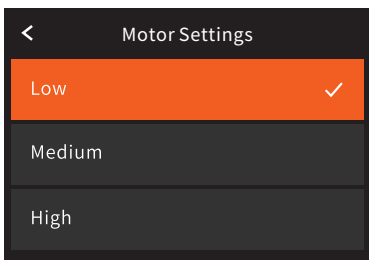

- ① If the motor torque is too low/high for the payload, the camera will shake and affect the gimbal performance. Please choose proper motor torque.
- ② When setting the motor torque, please make sure that three gimbal axes are unlocked and the gimbal is straightly put on a flat surface.
- ③ It is recommended to use auto-calibration. If the gimbal is not yet in the ideal state after the auto-calibration, you can use the customized adjustment or choose the level of the motor torque to be high/medium/low.
- ④ When the camera lens is changed, please balance the gimbal again and adjust the motor torque with the methods above.

Bluetooth Shutter Control

CRANE 4 supports Bluetooth shutter control, which allows you to wirelessly control the camera shutter without connecting a camera control cable. Before connecting the camera Bluetooth to CRANE 4, please turn on the camera's Bluetooth and enter pairing mode. Then tap the "Gimbal Setting" in the touchscreen menu, select "Bluetooth Shutter Control", make sure the camera Bluetooth is turned on and tap to confirm. CRANE 4 will then automatically search for the camera Bluetooth name. Select the Bluetooth name that needs to be connected, and finally confirm the connection on the camera.

- ① After CRANE 4 and the camera complete pairing and successfully connect Bluetooth for the first time, they can automatically connect to Bluetooth next time.
- ② When CRANE 4 and the camera are connected through both camera control cables and Bluetooth at the same time, the gimbal prioritizes controlling the camera function through the camera control cable.
- ③ After CRANE 4 and the camera are connected via Bluetooth, the Bluetooth connection can be disconnected in the Bluetooth shutter control menu.
- ④ For specific camera models that support Bluetooth control in CRANE 4 please visit the ZHIYUN official website www.zhiyun-tech.com to check the "CRANE 4 Camera Compatibility List" for the latest information.

Gimbal Modes Description

💡 Motors circled in red are free to move in line with the movement of the gimbal handle while motors circled in grey are locked.

Pan Follow mode (PF):

The tilt axis and roll axis motors are locked, and the camera rotates with the handle while panning horizontally. Push the joystick up/down to control the tilt axis angle, and push it left/right to control the pan axis of the camera.

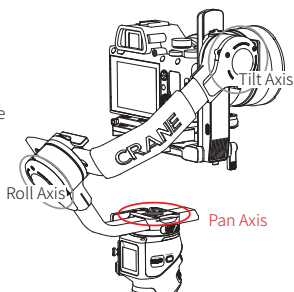

Lock mode (L):

All three motor angles are locked, and the camera orientation will not move with the rotation of the handle. Push the joystick up/down to change the tilt angle of the camera and left/right to change the horizontal orientation of the camera.

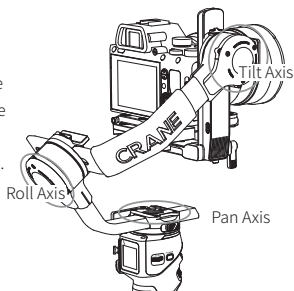

Follow mode (F):

The roll axis motor is locked, and the tilt axis and pan axis motors follow the rotation of the handle. Push the joystick up/down to change the tilt angle of the camera and left/right to change the horizontal orientation of the camera.

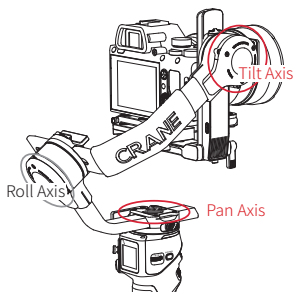

Point of View mode (POV):

All three motors move when the handle is rotated. Push the joystick up/down to change the tilt angle of the camera and left/right to change the horizontal orientation of the camera.

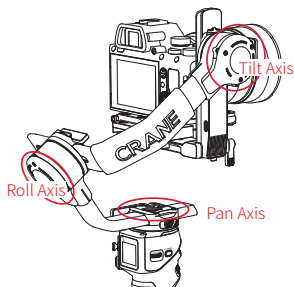

Vortex mode (V):

The tilt axis motor rotates upward by 90°, and the tilt axis, roll axis, and pan axis motors follow the rotation of the handle. Push the joystick to the left/right to control the rotation of the pan axis.

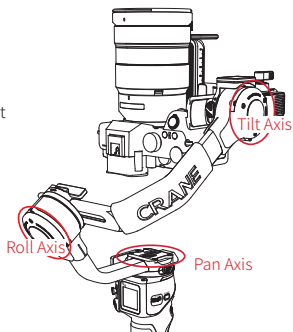

Go Mode (GO):

The roll axis motor is locked, and the tilt axis and pan axis motors quickly follow the rotation of the handle. Push the joystick up/down to change the tilt angle of the camera and left/right to change the horizontal orientation of the camera.

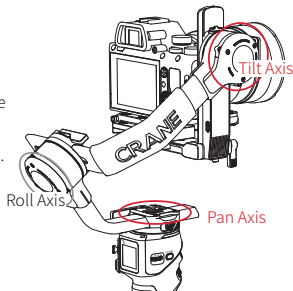

Portrait mode

The tilt axis motor rotates upward by 90° and the pan axis rotates counterclockwise by 90° . You can enter this mode for vertical filming.

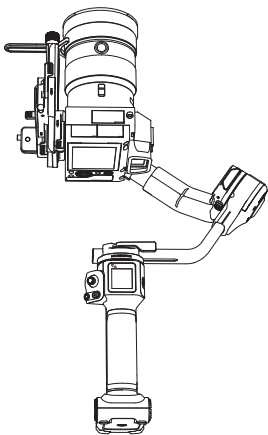

Manual Reposition

In Pan Follow mode (PF) and Lock mode (L), the camera can be rotated by a certain angle by hand. Hold it for 2s and the camera angle will be fixed at that angle after you release the camera.

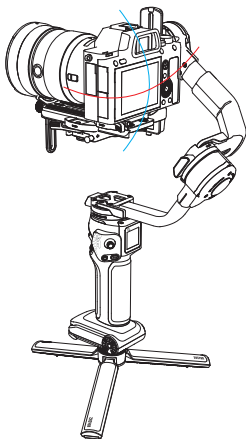

Use with TransMount Video Transmission Transmitter (AI) (hereinafter referred to as "transmitter AI")

Installing

1. Take out the transmitter mounting plate, mount the transmitter mounting plate to the bottom of the CRANE 4's level mount (note the direction of the notch), and use the wrench to tighten the screws.

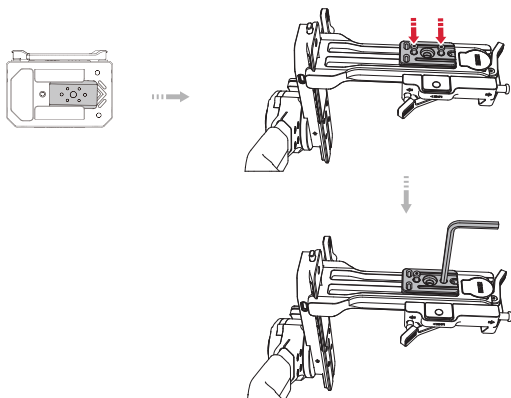

2. Place the transmitter AI with the mounting plate slot facing up, align the transmitter mounting plate, push the transmitter AI toward the tilt axis motor until it clicks into the safety lock to make sure of a firm installation.

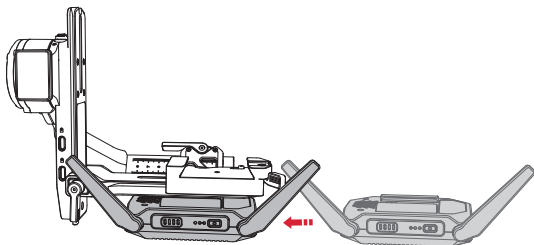

-  In order to have the best image transmission, please rotate the antenna to the position as shown in the image. The antenna can only be rotated in one direction. Please rotate properly. For more details, please read the user guide of transmitter AI.

Connecting

1. Take the gimbal-only cable (Type-C to Type-C LN-UCUC-A02), connect with the camera/image transmission control port of CRANE 4 and the Type-C charging/communication port of the transmitter AI.

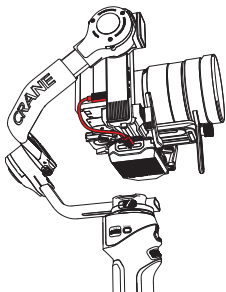



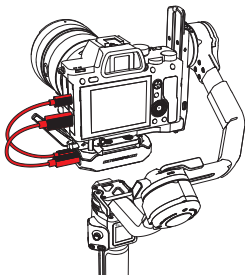

2. Take the camera control cable corresponding to the USB port model of the camera, connect to the camera control port of the transmitter AI and the USB port of the camera. Use the HDMI cable corresponding to the HDMI port model of the camera, connect to the HDMI video input port of the transmitter AI and the HDMI output port of the camera.



- ① CRANE 4 can also be used with TransMount Image Transmission Transmitter 2.0. The installation steps are similar to transmitter AI. Please choose proper cables when installing.
- ② It is recommended that the CRANE 4 and transmitter AI be shut down and powered off before plugging in or out the cable. The actual color of the cable is black. The red color used in the manual is only used for illustrative purposes.
- ③ To know how you can connect the camera control cable and the HDMI cable, please visit the official website of ZHIYUN (www.zhiyun-tech.com) to find "TransMount Video Transmission Transmitter AI Camera Compatibility List".
- ④ After installing the device, you need to adjust the balance of the CRANE 4.

Using

1. Power on CRANE 4, transmitter AI and camera. When the screen on CRANE 4 shows the icon[] and gives a “beep” sound, the connection is successful. You can then control the camera via the gimbal buttons.
2. Launch the “ZY Play” app. Select the CRANE 4 page and tap to connect. Select the Bluetooth name of your CRANE 4 to connect. (the CRANE 4 Bluetooth name can be found on the tilt axis USER ID: XXXX).
3. When the app enters the image transmission interface, tap the Wi-Fi icon [], and follow the instruction to connect the transmitter AI Wi-Fi (default password: 12345678). Tap the image transmission icon[], to enable image transmission. You can then watch the real-time footage of the camera on “ZY Play” app. You can also use the virtual joystick on the app to control the camera to take photos/shoot videos or control the gimbal to rotate.

 The transmitter AI should be used with the “ZY Play” app. To know how you can download the app, please see the method introduced in “How to Use the App” .

Downloading the App



Scan the QR code on the left (Android 5.0 and above, iOS 9.0 and above required) or search "ZY Play" in App Store or Google Play to download.

- ① "ZY Play" is an app dedicatedly designed for CRANE 4. When activated CRANE 4 via "ZY Play", you can also use it for firmware upgrades, virtual joystick control, six-side calibration, etc.
- ② ZY Play is subject to updates without notice. Please always refer to the latest version.

How to Connect

1. Power on CRANE 4 and turn on Bluetooth on the smartphone.
2. Launch the "ZY Play" app. Select the CRANE 4 page and tap to connect. Select the Bluetooth name of your CRANE 4 to connect (the CRANE 4 Bluetooth name can be found on the side of the tilt axis USER ID: XXXX).
3. If the CRANE 4 is being used for the first time, you need to activate the gimbal via "ZY Play" to use the advanced features in the app. Internet connection is required.
4. After the activation succeeds, you can enter the feature interface of ZY Play App.

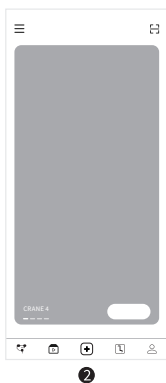
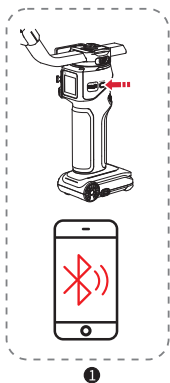

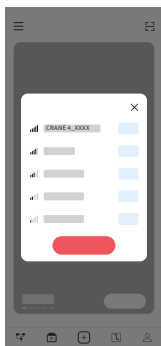

3

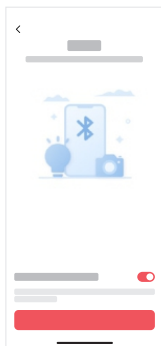

4

ZY Play Feature Description



💡 For more details of the “ZY Play” app features, please visit the official website of ZHIYUN (www.zhiyun-tech.com) and watch CRANE 4 video tutorials.

Circumstances When Calibration Is Needed

Calibrate the gimbal as needed.

| Calibration Reason | Calibration Method |
|------------------------------------------------------------------------------------------------------------------------------------------------------------------------------------------------------------------------------------------|----------------------|
| 1. Slight deviation is found in the level position after the initialization of the gimbal. 2. The gimbal has not been used for a long time. 3. The gimbal undergoes significant temperature differences in operation environments. | Six-side Calibration |
| Slight deviation is found in the tilt or roll angle in level position after six-side calibration of the gimbal. | Motor fine-tuning |

Six-side Calibration

1. Six-side calibration via APP:

According to the method introduced in "How to Use the App", please connect the gimbal to the APP, and enter "Settings"- "Six-side Calibration", then conduct the six-side calibration according to the prompt.

2. Six-side calibration via "Zhiyun Gimbal Tools":

Power on the gimbal and enter standby mode. Connect the charging/upgrade port of the gimbal to the computer with the Type-C USB cable, Open "Zhiyun Gimbal Tools", click "open" on the top and click "calibration" on the bottom. Please conduct the process according to the following steps. A "√" mark will appear after the calibration is completed.

- ① Please refer to the six-side calibration steps below. After the calibration is completed, please restart the gimbal.
- ② In simple terms, six-side calibration is to place all six sides of the tilt axis arm vertically to a level surface respectively.

Step 1

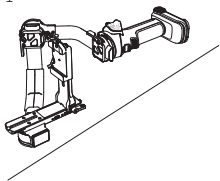

Step 2

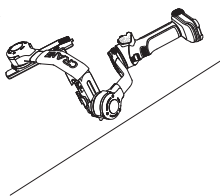

Step 3

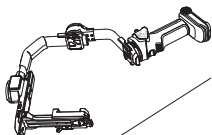

Step 4

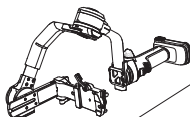

Step 5

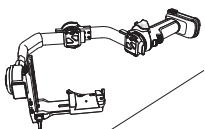

Step 6

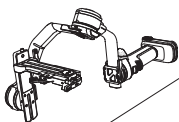

Motor Fine-tuning

Select the “Settings” in the touchscreen menu and select “Motor fine-tuning” to enter the tilt axis/roll axis angle fine-tuning interface.

Firmware Upgrade

You can use "Zhiyun Gimbal Tools" or "ZY Play" App to upgrade the firmware of CRANE 4.

Method One:

1. Visit the official website of ZHIYUN (www.zhiyun-tech.com), go to the CRANE 4 product page, click "Download", find the USB driver, the calibration upgrade tool and the firmware and download. (USB drivers are not required for Mac OS systems)
2. Install the driver, unzip the firmware for the documents with the ".ptz" file extension.
3. Connect the Type-C charging/upgrade port of CRANE 4 to the computer with the Type-C USB cable, power on CRANE 4.
4. Open "Zhiyun Gimbal Tools", click "Open", click "Firmware Upgrade". Click "Browse" under "Path" to select the latest firmware downloaded (with the ".ptz" file extension), and click "Upgrade" at the bottom to upgrade firmware.

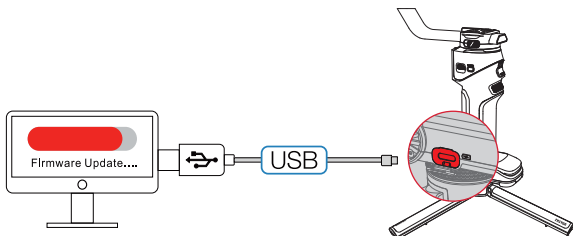

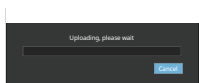
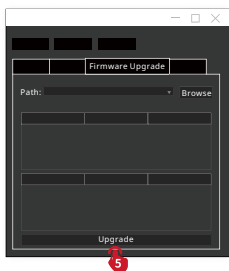
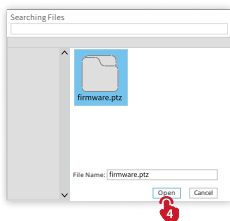
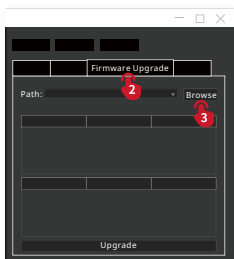
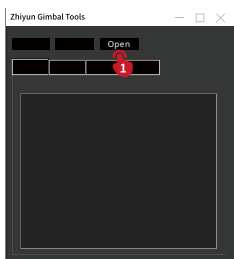

Method Two:

When CRANE 4 is connected to “ZY Play” app, if a firmware upgrade prompt pops up on the app, please follow the instructions to upgrade. Internet connection is required. To know how you can connect CRANE 4 to “ZY Play”, please check the method introduced in "How to Use the App".

- ① When upgrading via Method One, please wait until the screen displays that the upgrade is finished, then you can plug out the USB Type-C cable.
- ② Before upgrading the firmware, please ensure that the CRANE 4 has more than 50% power remaining. You will not be able to exit the app interface or access in the background during the upgrading process. Pay attention to the prompts on the app.

Product Model: CR122

| Item | Min. | Standard | Max. | Remark |
|-----------------------------------------|-------|---------------------|---------|--------------------|
| Operation Voltage | 11V | 14.8V | 16.8V | |
| Operation Current | 200mA | - | 14500mA | |
| Output Voltage (Camera Control Port) | - | 5V | - | |
| Output Current (Camera Control Port) | - | 1A | - | |
| Tilt Mechanical Range | -72° | - | +142° | |
| Roll Mechanical Range | -251° | - | +71° | |
| Pan Mechanical Range | - | 360° | - | |
| Controllable Tilt Angle | -71° | - | +136° | |
| Controllable Roll Angle | -35° | - | +35° | |
| Controllable Pan Angle | - | 360° | - | Unlimited Rotation |
| Operation Temperature | -10°C | 25°C | 45°C | |
| Battery Capacity | - | 2600mAh | - | |
| Battery Runtime | | 12H | | Lab Data 1 |
| Charging Time | | 1H 50min | | Lab Data 2 |
| Gimbal Net Weight | | 1673g | | Without tripod |
| Gimbal Size (Folded) | | 340*280*70mm | | |
| Gimbal Size (Expanded) | | 411.6*182.7*237.9mm | | |

| Item | Min. | Standard | Max. | Remark |
|----------------------------------------------|------|--------------------------------|------|--------|
| Bluetooth | | Bluetooth 5.0 | | |
| EIRP | | < 10dBm | | |
| Operation Frequency | | 2.4GHz | | |
| Camera Charging | | Able to charge 5V / 1A cameras | | |
| 1/4" Rosette Mount Screw Thread Carry Weight | | Carry weight \leq 6000g | | |
| Touchscreen Size | | 1.22inch | | |

Lab Data 1: This data was obtained under the condition of a fully charged CRANE 4, mounted with Canon 5Ds R+ EF24-105mm f/4L. The gimbal is balanced and placed in the static status, and the battery only supplying power to the gimbal, at an ambient temperature of 25°C. The maximum runtime was 12 hours. When the battery supplies power to the gimbal and charges the camera simultaneously, the battery life will be shortened. Please determine whether to enable the camera USB power supply function as required. The actual usage time will vary depending on the duration of CRANE 4 use, the number of battery charge and discharge cycles, and the battery activity. The longer the CRANE 4 has been used, the more battery charge and discharge cycles, and the lower the battery activity, the shorter the continuous usage time.

Lab Data 2: This data was obtained under the condition of using 15V PD fast charging at an ambient temperature of 25°C, and the charging time was 1 hour and 50 minutes. The charging time may vary due to environmental factors, and actual results may differ. In addition, the lower the charging environment temperature, the smaller the charging current, and the longer the charging time.

Any data mentioned in this user guide is the result of internal testing at ZHIYUN Lab. Under different objective conditions, there may be varying degrees of error in the data. Please refer to actual experience with the device.

Thank you for purchasing this product. The information contains herein affects your safety, legitimate rights and obligation. Please read this instruction carefully to ensure proper configuration before use. Failure to read and follow this instruction and warnings herein may result in serious injury to you or bystanders, or damage to your device or property. Guilin Zhishen Information Technology Co., Ltd (hereinafter referred to as "ZHIYUN") reserves all rights for final explanation on this instruction and other documents related to the product. The information is subject to update without notice. Please visit www.zhiyun-tech.com to obtain the latest product information.

By using this product, you hereby signify that you have read this document carefully and that you understand and agree to abide by the terms and conditions herein. You agree that you are solely responsible for your own conduct while using this product, and for any consequences thereof. You agree to use this product only for purposes that are proper and in accordance with all terms, precautions, practices, policies and guidelines ZHIYUN has made and may make available.

ZHIYUN accepts no liability for damage, injury or any legal responsibility incurred directly or indirectly from the use of this product. Users shall observe safe and lawful practices including, but not limited to, those set forth herein.

ZHIYUN™, TransMount™ are the trademark of Guilin Zhishen Information Technology Co., Ltd and its affiliates. All product names or trademarks referred to herein are trademarks or registered trademarks of their respective holders.

Reading Tips

Legends:  Hints and Tips

 Important

WARNING

Read the ENTIRE User Guide to become familiar with the features of this product before operating. Failure to operate the product correctly can result in damage to the product or personal property and cause serious injury. This is a sophisticated product. It must be operated with caution and common sense and requires some basic mechanical ability. Failure to operate this product in a safe and responsible manner could result in injury or damage to the product or other property. This product is not intended for use by children without direct adult supervision. DO NOT use with incompatible components or in any way otherwise as mentioned or instructed in the product documents provided by ZHIYUN. The safety guidelines herein contain instructions for safety, operation and maintenance. It is essential to read and follow all of the instructions and warnings in the User Guide, prior to assembly, setup or use, in order to operate the product correctly and avoid damage or serious injury.

Safe Operation Guidelines

1. This product is a high-precision control device. Damage may be caused to this product if dropped or subject to external force, and this may result in malfunction.
2. Make sure the rotation of the gimbal axes is not blocked by external force when this product is turned on.
3. This product is not waterproof. Prevent contacts of any kind of liquid or cleaner with the this product. It is recommended to use dry cloth for cleaning.
4. Protect this product from dust and sand during use.

Warranty Period

1. Customers are entitled to replacement or free repair service in case of quality deficits found in the product within 15 days upon receipt of the product.
2. Customers are entitled to free repair service from ZHIYUN for any product proven defective in material or workmanship that results in product failure during normal consumer usage and conditions within the valid warranty period, which is 12 months counting from the date of selling. However, warranty period varies by product component and country of purchase. Please contact our after-sales service team on ZHIYUN official website or your place of purchase for detailed warranty information.

Warranty Exclusions

1. Products subjected to unauthorized repair, misuse, collision, neglect, mishandling, soaking, accident, and unauthorized alteration.
2. Products subjected to improper use or whose labels or security tags have been torn off or altered.
3. Products whose warranty has expired.
4. Products damaged due to force majeure, such as fire, flood, lightning, etc.

Warranty Claim Procedure

1. If failure or any problem occurs to your product after purchase, please contact a local agent for assistance, or you can always contact ZHIYUN's customer service through email at info@zhiyun-tech.com or website at www.zhiyun-tech.com.
2. Your local agent or ZHIYUN's customer service will guide you through the whole service procedure regarding any product issue or problem you have encountered. ZHIYUN reserves the right to reexamine damaged or returned products.

Customer Information

Customer Name:

Phone Number:

Address:

Sales Information

Sales date:

Product Serial Number:

Distributor Name:

Distributor's Contact Number:

First Maintenance Record

Service Date:

Repairman Signature:

Cause of Problem:

Service Result:

Solved

Unsolved

Refunded/Replaced



Website



Weibo



Vimeo



Google+



Facebook
(Zhiyun Support)



Facebook
(Zhiyun Tech)



Youku



Youtube



Wechat



Instagram

Tel: +86 400 900 6868

USA Hotline: +1 808-319-6137,9:00-18:00 GMT-7,Mon-Fri

Europe Hotline: +49 (0) 61018132180,10:00-17:00 GMT+1,Mon-Fri

Web: www.zhiyun-tech.com

E-mail: info@zhiyun-tech.com

Address: 09 Huangtong Road, Tieshan Industrial Zone, Qixing District, Guilin, 541004, Guangxi, China

Certificate of Quality

This product is confirmed to meet quality standards and permitted for sale after strict inspection.

QC Inspector: _____



For full product information, please visit ZHIYUN's official website: Content on www.zhiyun-tech.com is subject to update without notice.

ZHIYUN™ is a trademark of ZHISHEN

All product names or brands referred to hereunder may be trademarks or registered trademarks of their respective holders.

Copyright © 2023 ZHISHEN. All rights reserved.

ZHIYUN-TECH.COM